

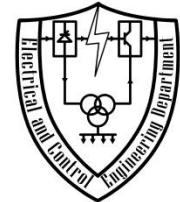

College of Engineering and Technology
Electrical and Control Engineering Department



Automated Industrial Systems I

EE512

EX1: Direct Online Motor Starter

Lecturer name:

Student name :

Registration # :

Experiment 1

Direct Online Motor Starter

1- Objective

To start and stop a three phase induction motor by Direct On Line (DOL) Starter.

2- Theory

A Direct On Line (DOL) or across the line starter applies the full line voltage to the motor terminals.

This is the simplest type of motor starter. A DOL motor starter also has protection devices and, in some cases, condition monitoring. Smaller sizes of direct on-line starters are manually operated; larger sizes use an electromechanical contactor (relay) to switch the motor circuit. Solid-state direct on line starters also exist.

A direct on line starter can be used if the high inrush current of the started motor does not cause excessive voltage drop in the supply circuit. The maximum size of a motor allowed on a direct on line starter may be limited by the supply utility for this reason. For example, a utility may require rural customers to use reduced-voltage starters for motors larger than 4KW (5HP).

DOL starting is sometimes used to start small water pumps, compressors, fans and conveyor belts.

In the case of an asynchronous motor, such as the 3-phase squirrel-cage motor, the motor will draw a high starting current until it has run up to full speed. This starting current is typically 6-7 times greater than the full load current. To reduce the inrush current, larger motors will have reduced-voltage starters or variable speed drives in order to minimize voltage dips to the power supply, or series resistance and inductance can be added.

3- Instruments & Equipments

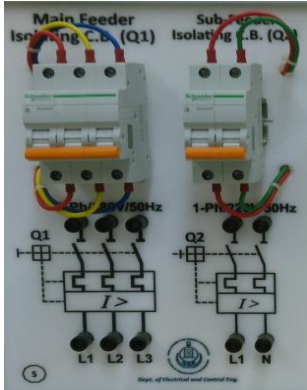
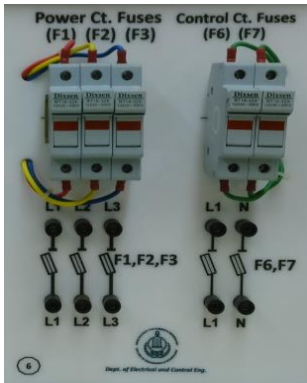
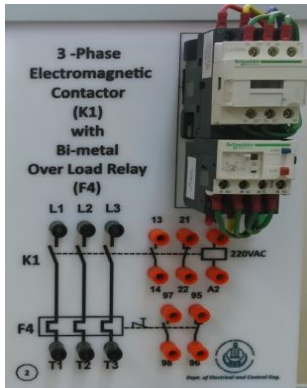
<p>Three phase induction motor</p>	
<p>Main and Sub feeder isolating circuit breakers (board #5)</p>	
<p>Power and control circuits fuses (board #6)</p>	
<p>Three phase electromagnetic contactor with bi-metal overload relay (board #2)</p>	

Indicating lamps and Pushbuttons
(board #1)



Multimeter



Digital stroboscope



Wattmeter



4- Connection

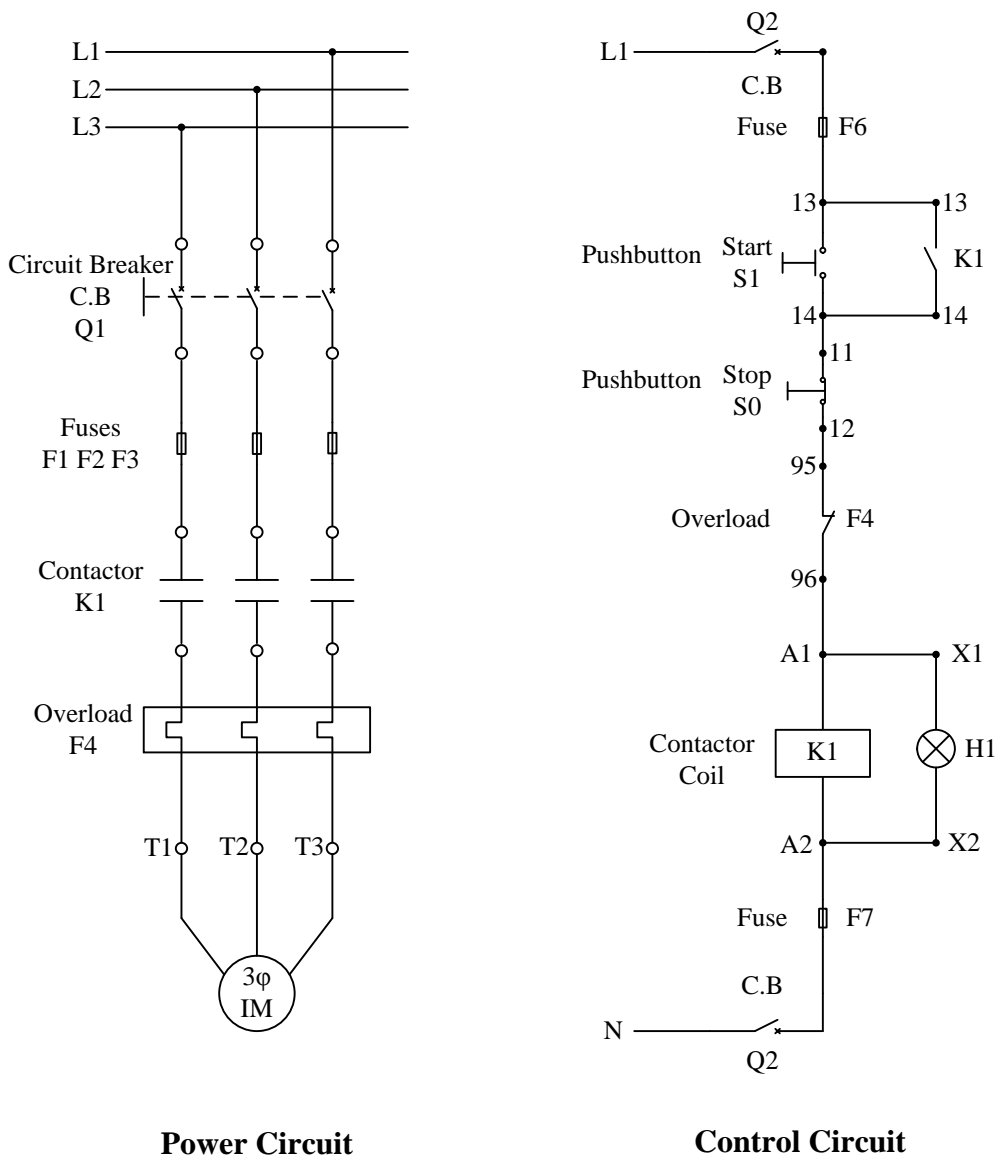

Power and Control circuits connections diagram

5- Procedure

- Connect the circuits as shown in the diagram.
- Switch on the main and sub feeder isolating circuit breakers (Q1, Q2).
- Use the start and stop pushbuttons for motor operation.
- Measure the current, voltage, power and the no load speed of the motor.

6- Results

Current =A
 Voltage =V
 Power =W
 Speed =FPS

7- Connect the power and control circuits on the following figure

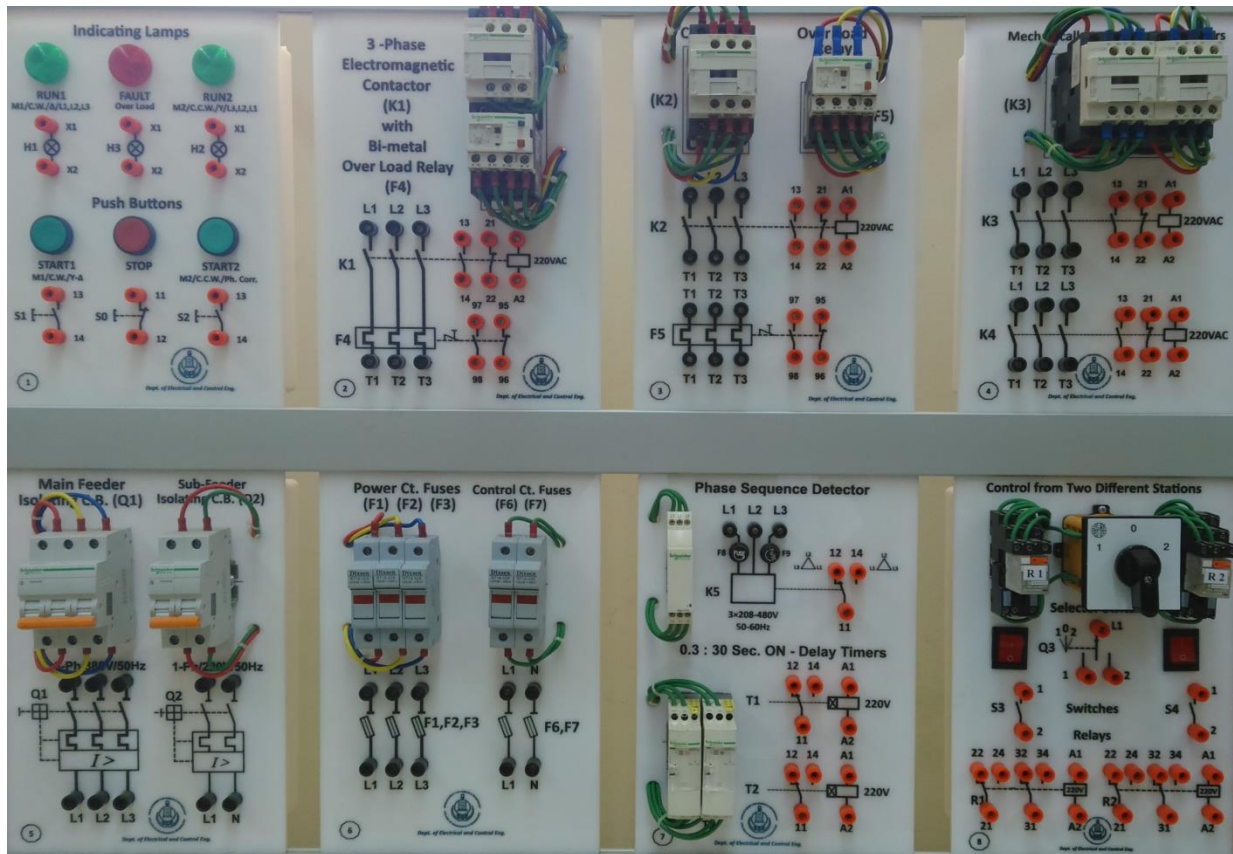

8- Add your own comments

.....

9- Use internet resources to provide advantages, disadvantages and then discuss different applications of DOL motor starter circuit

.....

