

# A Proposed Fuzzy Controller for MPPT of A Photovoltaic System

Haitham Hassan

Electrical and Control Eng., AAST  
Arab Academy for Science and Technology  
Alex, Egypt  
Haithamhassanib@aast.edu

Mostafa Abdel Geliel

Electrical and Control Eng., AAST  
Arab Academy for Science and Technology  
Alex, Egypt  
maelgeliel@yahoo.com

Mahmoud Abu-Zeid

Electrical and Control Eng., AAST  
Arab Academy for Science and Technology  
Alex, Egypt  
mca@aast.edu

**Abstract** – Renewable energy sources have a great concern nowadays to overcome the conventional energy sources problem. The solar energy is one of the renewable energy that is implemented in different scale. The Photovoltaic cell (PV) is used to convert solar energy into electrical energy. The PV has a non-linear characteristic between its current and voltage. In addition, the PV power is highly sensitive to the atmospheric conditions, in particular temperature and solar radiation. This makes the PV has different equilibrium points. Therefore, selecting equilibrium points that extract the maximum allowable power of the PV is mandatory in order to enhance the PV system efficiency and robustness. The controller that can select the optimal operating point is defined as the Maximum Power Point Tracking (MPPT). MPPT is addressed by different techniques scattered in literatures. This paper proposes a modified fuzzy algorithm for MPPT of the PV system in order to enhance its performance, in transient and steady state, and robustness and accelerate the recovery time due to a sudden change in the connected load. A comparison between the proposed technique and conventional techniques is illustrated. Simulation and practical results are addressed.

**Keywords**— MPPT, FUZZY, BUCK-BOOST

## I. Introduction

Since modern civilization makes the energy demand is continuously growing, the reserve of classical energy sources is not sufficient to satisfy the demand. Moreover, the conventional energy sources have bad impact on the environment. Hence, renewable energy sources have a great attention, in particular the solar energy, due to its ability to produce clean power.

The renewable energy sources such as solar energy, wind energy, geothermal, hydro, and etc. have a considerable ratio among the other sources for electric power generation. The selection of renewable energy source among all renewable sources depends mainly on the available source and its generation cost. The generation cost of renewable energy is still more expensive than the conventional sources but the rate of cost reduction is increasing very fast.

Egypt is one of the countries that have a shortage in classical energy source while it is rich of the solar energy. Therefore, the technology of using solar energy is widely

applied in different fields. In addition, there is a great potential to increase the applications of solar energy in particular electrical energy generation.

The solar energy can be directly converted to electric energy through PV cells. The PV system installation cost is high in comparison with the classical electric energy systems. Moreover the PV systems have low conversion efficiency [1]. In addition, the PV has a nonlinear characteristic between its current and voltage, and the generated PV power is highly sensitive to atmospheric conditions (Temperature and Solar Insulation). Hence, it is necessary to operate the PV at an equilibrium point that has the maximum PV efficiency, which is called the Maximum Power Point (MPP). When a PV array is connected to a resistive load directly; the operating point of the system depends mainly on the equivalent resistance connected to PV. The best equivalent load resistance is that could extract the maximum power from the PV array at a certain atmospheric condition. This is called the optimal load resistance at a certain atmospheric condition. Hence, it is necessary to make the equivalent load resistance always equal to the optimal one. The optimal equivalent load resistance can be obtained at any resistive load by introducing a DC-DC converter between the load and PV module.

Maximum Power Point Tracking (MPPT) controller strategies are designed to modulate the operating point of the system to get the maximum power, through a DC-DC converter which is often connected between the PV array and the load as illustrated in block diagram shown Fig. 1.

Many MPPT techniques have been addressed in literature see for example [1]-[5]. These techniques can be classified either conventional such as perturbed and observe [1], Fractional open circuit [2] or intelligent such as Fuzzy [3] and Neuro-Fuzzy [4].

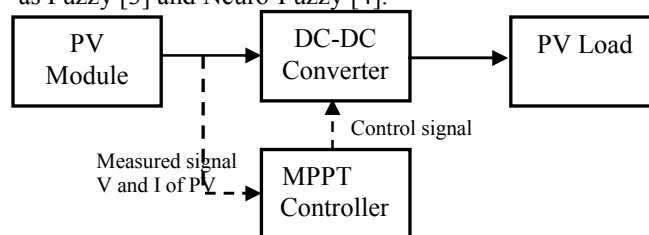

Fig. 1 PV with MPPT Configuration

Fuzzy Logic Controller (FLC) is robust controller that has a high capability to handle uncertainties due to atmospheric condition variation and nonlinearities. Fuzzy controller are applied for MPPT either standalone controller [3], [8] or combined with other such as neural network [4] and fractional open circuit [9].

Most of MPPT techniques are designed only to be robust for atmospheric condition. The goal of the work, in this paper, is to extract the maximum allowable power of PV system either in different atmospheric condition and/or load resistance variation, *i.e.* the suggested MPPT technique should be robust in both atmospheric conditions and load variation. An adaptive Fuzzy controller is suggested to control a buck-boost DC-DC converter, which is called modified fuzzy controller.

Some tracking control techniques will be discussed in this paper such as Perturb and Observe [1], Fractional Open-Circuit Voltage [2], Fuzzy Logic [3] in order to be compared with the Proposed Modified Fuzzy Logic. Each technique should track the MPP under different operating atmospheric conditions and the load variations in an accurate and fast manner.

The paper is organized as follow: Section II gives a brief idea about the PV model and its characteristics; section III reviews the some of MPPT to be compared with the proposed one. Section IV explains the proposed MPPT technique; Section V illustrates the simulation results; section VI introduces the practical results; finally, section VII discusses the conclusion and future work.

## II. PHOTOVOLTAIC'S CHARACTERISTIC ANALYSIS

The photovoltaic cell is considered as a current source shunted by a diode that the saturation current passes through, as shown in Fig. 2 [1],[6], [7].

The PV model equation is given as:

$$I = N_p I_{ph} - N_p I_{rs} [\exp(q*V/k*T*A*N_s) - 1] \quad (1)$$

$$I_{rs} = I_{rr} *(T/Tr)^3 * [ \exp(q*E_G*(1/Tr - 1/T)/k*A) ] \quad (2)$$

$$I_{ph} = [ I_{scr} + k_i(T - Tr) ] * \frac{G}{1000} \quad (3)$$

where I is the PV array output current, V is the PV array output voltage,  $I_{ph}$  is the photo-current,  $I_{rs}$  is the cell reverse saturation current,  $I_{rr}$  is the reverse saturation current at  $T_r$ ,  $T_r$  is the reference temperature,  $I_{scr}$  is the cell short circuit current at  $T_r$ , A is the ideality factor for a p-n junction, q is the electric charge,  $E_G$  is the band gap energy of the semiconductor used in the cell, K is the Boltzmann's constant,  $K_i$  is the short circuit current temperature coefficient, T is the junction temperature in Kelvin,  $N_p$  is the number of modules connected in parallel,  $N_s$  is the number of PV cells connected in series, and G is the solar irradiance .

It is clear that the PV output current depends on the temperature and the solar irradiance [1] as shown in (1), (2) and (3).

The solar irradiance has large influence on the generated current from the PV cell; the relation between the current and the solar radiation is directly proportional, as shown in the odd numbers in Fig 3.

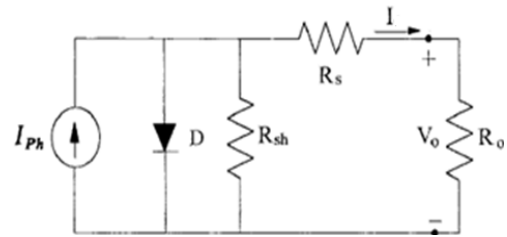

Fig.2 Photovoltaic Equivalent Circuit Diagram

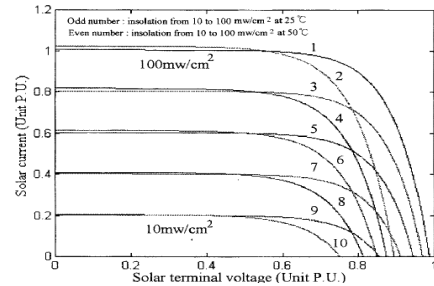

Fig.3 The Effect of cell's temperature and solar radiation on PV Cell's I-V Curve [1]

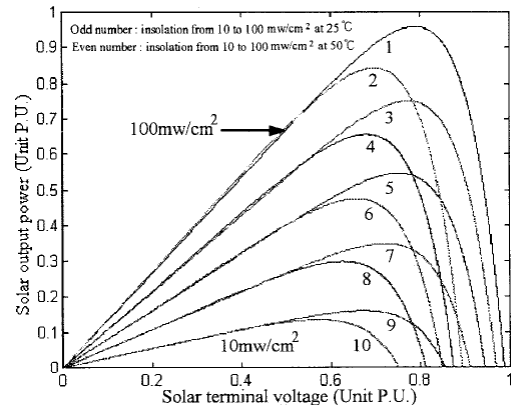

Fig. 4 The Effect of cell's temperature and solar radiation on PV Cell's P-V Curve

The cell's temperature has also an effect on the output voltage from the PV cell; the relation between the temperature and the output voltage is inversely proportional, as shown in the even numbers in Fig 3

So, the solar radiation affects on the output power of the PV cell more than the cell's temperature, the output power increases with increase of the solar irradiance. On the other hand, the output power decreases with the increase of the temperature as shown in Fig 4.

## III. THE MPPT TECHNIQUES

The MPP occurs at the knee of the PV's I-V curve, this point meets specific conditions such as temperature, solar radiation and certain connected load. Any change in these conditions leads the operating point of the system to move away from the MPP. The aim of the MPPT techniques is to move the system's operating point toward the MPP, if any of the specified conditions change. These methods change the system operating point by changing the duty cycle of the connected DC-DC power converter, as shown in Fig 5. The DC-DC converter used is a buck-boost converter to modulate the output voltage of the converter

either by increase or decrease its value in order to compensate the load variation and extract always the maximum power of the PV system [7]. The inductor and capacitor of buck-boost converter shown in Fig. 5 are designed to reduce the voltage and current ripple of the load.

Among the MPPT techniques in literature, three of the most common techniques will be discussed and compared with the proposed one: perturb and observe, fractional open circuit voltage, and fuzzy logic [3],[5].

**A. Perturb and Observe method:**

This method perturbs the system' operating point by changing the duty cycle of the DC-DC converter, and observes the output power from the PV system till reaches to the MPP, as in Fig 6. This method is not reliable under rapidly changes in the temperature and solar radiation. Moreover, its output response has big oscillations.

The flowchart in Fig 7 shows the perturbation process of this algorithm.

**B. Error method:**

This method is similar to the perturb and observe method, but it changes the duty cycle of the power converter till the change of the output power with respect to the change of the PV's output voltage becomes zero ( $\frac{\Delta p}{\Delta v} = 0$ ).

**C. Fractional Open- Circuit Voltage:**

There is a relationship between  $V_{MPP}$  and  $V_{OC}$  of the PV array, under different solar irradiances, as shown in Fig.8. It can be noticed that the voltage at the MPP ( $V_{MPP}$ ) has a fractional value of the open circuit voltage of the PV array. It is found that the factor "k" changes between 0.71 and 0.78 for a specific PV array at different irradiances and temperature levels [6].

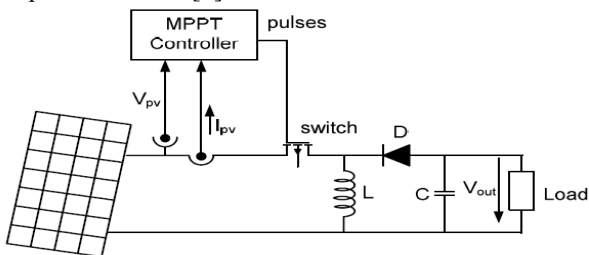

Fig.5 PV system with MPPT controller

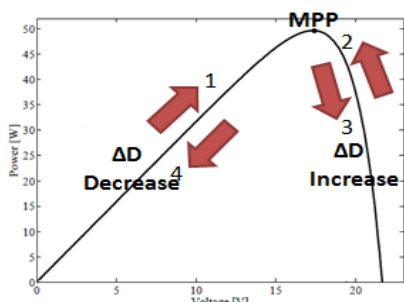

Fig. 6 P-V Curve of a Photovoltaic Cell at Specific Atmospheric Conditions

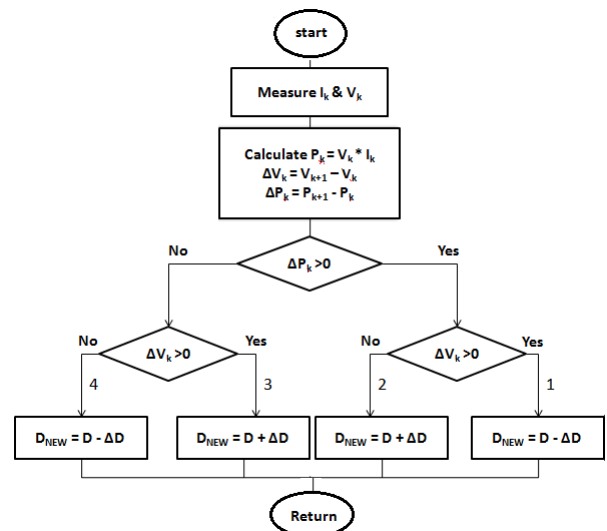

Fig. 7 The Perturb and Observe Algorithm

$$V_{MPP} \approx k V_{OC} \tag{2}$$

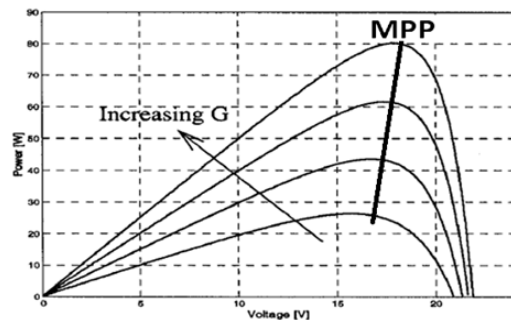

Fig.8 Location of the MPP under Increasing Irradiance [5]

Fig. 8 shows that the PV array's voltage at the MPP changes slightly at different solar irradiances levels (at constant temperature  $T=25^\circ C$ ). The  $V_{MPP}$  is almost about 76 % of the open circuit voltage.

This control algorithm requires continuously measurements of the  $V_{OC}$  of the PV array under the operating atmospheric conditions. So, a Static Switch is needed in the PV array. The switch must be connected in series to open the circuit (disconnect the PV array from the connected load) and this consequently reduces the total energy generated by the PV system.

**D. Fuzzy Logic:**

This method also aims to track the MPP in fast and accurate manner. It produces a suitable duty cycle for the DC-DC converter till the error becomes Zero ( $\frac{dp}{dv} = 0$ ). The error and change in error can be calculated from equations (4) and (5).

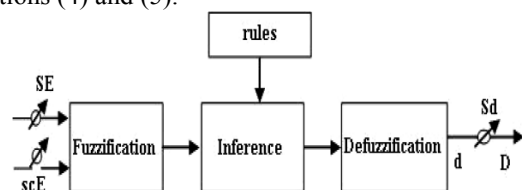

Fig. 9 The General Diagram of The Fuzzy Logic Controller

The components of the Fuzzy Logic Controller (FLC) are shown in Fig. 9 [3]. The system design is simple because it needs only two signals from the PV array (Error signal (E) and Change in Error signal (CE)). [7], [8].

$$E(n) = \frac{P(n) - P(n-1)}{V(n) - V(n-1)} \quad (4)$$

$$CE(n) = E(n) - E(n-1) \quad (5)$$

The fuzzy logic controller output is a suitable duty cycle for the dc converter according to its two input signals (E & CE) as shown in Fig. 10.

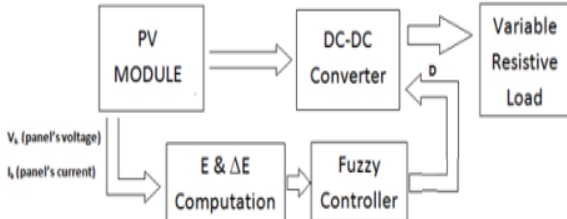

Fig. 10 PV System with Fuzzy logic MPPT Algorithm

#### IV THE PROPOSED ADAPTIVE FUZZY LOGIC

To enhance a FLC performance due to atmospheric conditions and load variation, a modified fuzzy logic controller is combined with fractional open circuit voltage [9]. It tracks the MPP more rapidly than the fuzzy logic method, but it depends on knowing the value of ( $V_{MPP}$ ) of the PV array under the operating atmospheric conditions. It normally uses the Fractional Open-circuit Voltage algorithm, so it needs the value of  $V_{OC}$  to compute  $V_{MPP}$  under the operating atmospheric conditions. It requires always measurements for the open circuit voltage ( $V_{OC}$ ) of the PV array. So, it is required to another voltage transducer for the voltage measurement and a switch for opening the circuit. This open circuit leads to energy loss which decreases the system efficiency. The main limitation of this technique is that it requires disconnecting the PV to measure the  $V_{OC}$  in order to modify the FLC parameters. Moreover, it does not completely address load variation. Therefore, an Adaptive Fuzzy Logic Controller (AFLC) is introduced in order to handle atmospheric and load variations more fast and robust. The block diagram of the AFLC is illustrated in Fig. 11. It has an additional feed-forward loop to adapt the output of nominal FLC as before. The output duty cycle of FLC is biased by a certain amount depending on the difference between current voltage of PV and the nominal PV open circuit voltage ( $V_{OC}$ ) as shown in (6).

$$D(n) = D_f(n) + \alpha \cdot g(k \cdot V_{OC} - V_{pv}(n)) \quad (6)$$

Where  $D$  is the current duty cycle,  $D_f$  is the fuzzy output duty cycle,  $g$  is the adaptation function it is a linear function with dead band ( $\Delta v$ ),  $k$  is the fractional open circuit voltage ration,  $\alpha$  is the adaptation parameter,  $n$  is the sample number, and  $V_{OC}$  and  $V_{pv}$  are the nominal open circuit and PV voltages respectively.

As the load or atmospheric condition change,  $D_f$  will deviate from the optimal one. Hence, adaptation mechanism will change  $D$  by a reasonable amount in order

to accelerate the system. When the PV array's connected load exposes to a big change, the PV array's operating point deviates largely from the MPP. The proposed fuzzy makes the operating point returns rapidly near the MPP depending on the difference between the array's operating voltage and the  $V_{MPP}$  as shown in Fig 11.

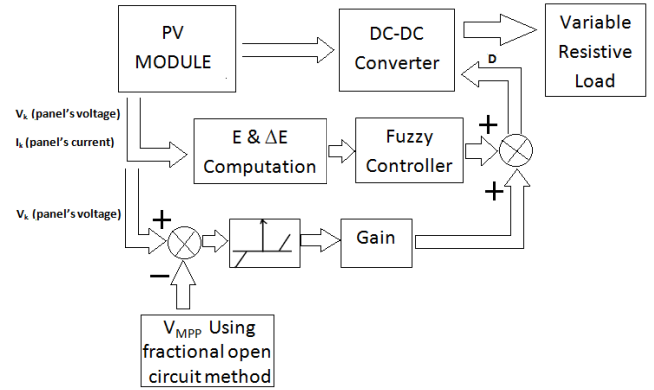
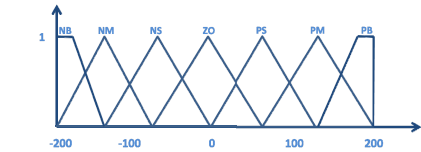

Fig. 11 The Proposed Modified Fuzzy MPPT Method

There is a dead band region at which the proposed fuzzy is not operating (when the difference between the array's operating voltage and the  $V_{MPP}$  is being small).

The designed Membership function for AFLC for inputs (E and  $\Delta E$ ) and output (duty cycle) are shown in Fig. 12



(a) The membership Function of the Error Signal

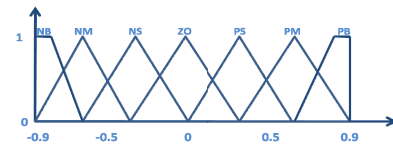

(b) The Membership Function of the Change of Error Signal

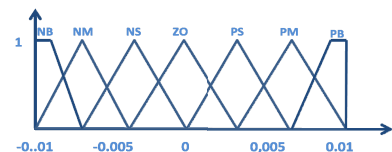

(c) The Membership Function of the Output Duty Cycle for the Power Converter

Fig 12 Different Membership Functions of the Fuzzy Logic System

The Rules between the input variables are listed in Table 1.

Table 1: The Rules of The fuzzy Logic System

$\Delta E$	NB	NM	NS	ZO	PS	PM	PB
E	NB	NB	NB	NB	NM	NS	ZO
NM	NB	NB	NM	NM	NS	ZO	PS
NS	NB	NM	NS	NS	ZO	PS	PM
ZO	NB	NM	NS	ZO	PS	PM	PB
PS	NM	NS	ZO	PS	PS	PM	PB
PM	NS	ZO	PS	PM	PM	PB	PB
PB	ZO	PS	PM	PB	PB	PB	PB

## V. Simulation Results

A PV panel with the following specification is used in both simulation and practical results: ( $I_{SC} = 18 \text{ A}$ ,  $V_{OC} = 20\text{V}$ ,  $P_{MAX} = 285\text{Watt}$ ,  $V_{MPP} = 17 \text{ V}$ ,  $I_{MPP} = 16\text{A}$ ). Since the atmospheric variation is so slow with respect to the load variation, the atmospheric condition is fixed in the simulation while the load is changed suddenly. The load is increased suddenly to twice its nominal value from 6A to 12 A. The MPPT changes buck-boost DC-DC converter duty cycle in order to change the output voltage to maintain the PV power at the maximum value.

Fig 12 shows the PV panel and load power using different MPPT techniques under the load variation (6A: 12A at 0.5 sec). It can be noticed that the PV panel's power reaches to the maximum ( $P_{MAX} = 285 \text{ W}$ ) using the different technique but the main difference is the reaction time and efficiency.

The perturb and observe response is shown in Fig. 12(a); it is clear that settling time is 0.25 sec from start and the recovery time after load change (at 0.5 sec) is 0.1 sec i.e the load absorbs the maximum power again at 0.6 sec. almost the same response is obtained by the modified perturb and observe method which is named Error as in fig. 12(b). Fuzzy controller gives better response than the perturb and observe as shown in Fig. 12(c). it is clear that the faster response either in settling (0.01sec) and recovery (0.01sec) is the proposed adaptive fuzzy as shown in Fig. 12(d).

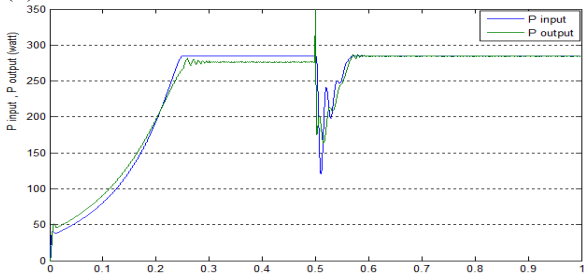

(a) Perturb and Observe Method

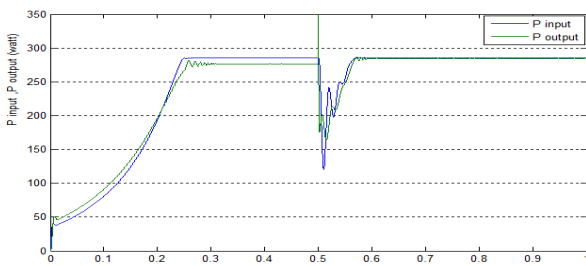

(b) Error Method

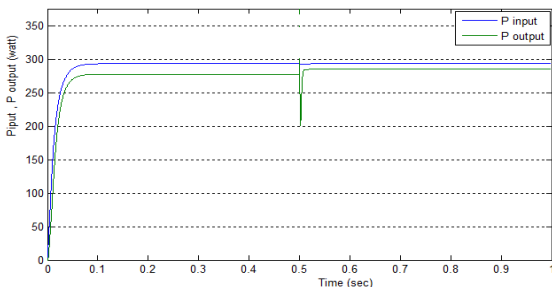

(c) Fuzzy Logic Method

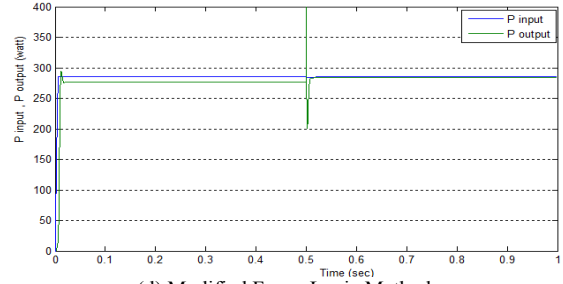

(d) Modified Fuzzy Logic Method

Fig.11 The PV Panel's Power and Load's Power Using Different MPPT Techniques (a) Perturb and Observe Method, (b) Incremental Conductance Method, (c) Error Method, (d) Fuzzy Logic Method, (e) Modified Fuzzy Logic Method

## VI. Experimental Validation

The MPPT techniques tested in the simulation are implemented on real 285 watt PV panel. The back-Boost DC-DC converter is designed. The configuration shown in Fig 13 shows the architecture of the experimental test rig.

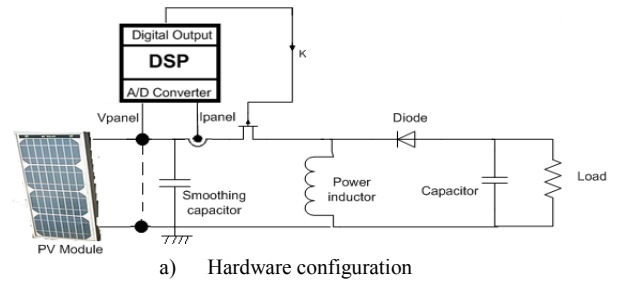

a) Hardware configuration

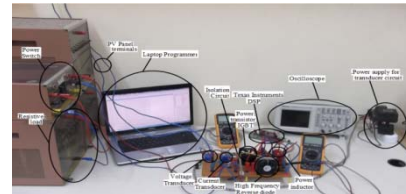

b) Photograph of setup

Fig 13 The Overall System Hardware Implementation

A Texas Instruments 32-bit microcontroller TMS320F28335 experimental board shown in Fig 13 was used as a controller with a clock frequency of 150MHz. This digital control has a high feature of functionality and flexibility rather than cost. It is more economical and flexibility.

A single Switch Buck-Boost was used as a power converter for the PV system. The designed inductor is 5 mH and the capacitor is 200 $\mu\text{F}$ - 50V.

The system photograph shown in Fig 13(b) illustrates the real connection of the implemented system.

The Perturb and Observe method shows a slightly large rise time as shown in Fig 14. It contains large oscillations (about 80 watt). The PV input power to the power converter, voltage and current are shown in Fig. 14. When the maximum power is tracked, the PV array's voltage and current close to their values at maximum power ( $V_{MPP}$  and  $I_{MPP}$ ).

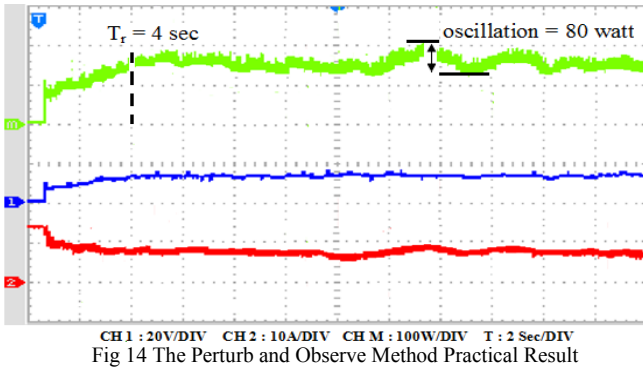

Fig 14 The Perturb and Observe Method Practical Result

The PV array's maximum power, voltage and current using error method are shown in Fig 15. The Error method produces results better than perturb and observe method, but the rise time is same. On the other hand, the power oscillations are reduced slightly.

Fuzzy logic response is shown in Fig. 16. The Fuzzy Logic method is more effective and practical for MPPT in the PV systems. It is robust at different atmospheric conditions. The rise time and power oscillations are improved as shown in Fig 16.

The Proposed Fuzzy Logic Method depends on the relation between the open circuit voltage of the PV array and its temperature. The temperature is almost does not change clearly during the day. It is considered that the voltage at the MPP ( $V_{MPP}$ ) is around 17 V. This method accelerates the tracking process; the rise time is decreased to 0.8 Sec, as shown in Fig 17. The power oscillations are also reduced.

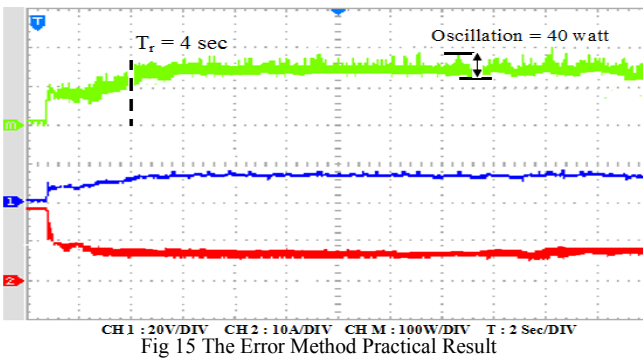

Fig 15 The Error Method Practical Result

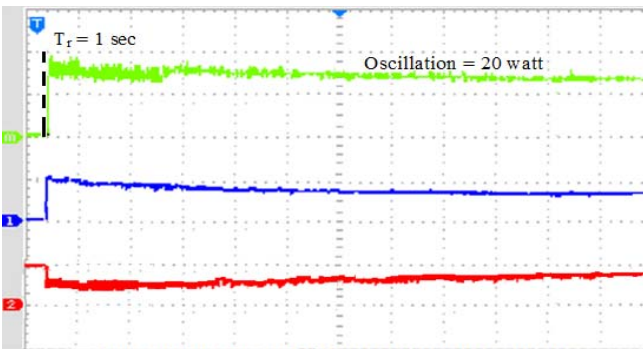

Fig 16 The Fuzzy Logic Method Practical Result

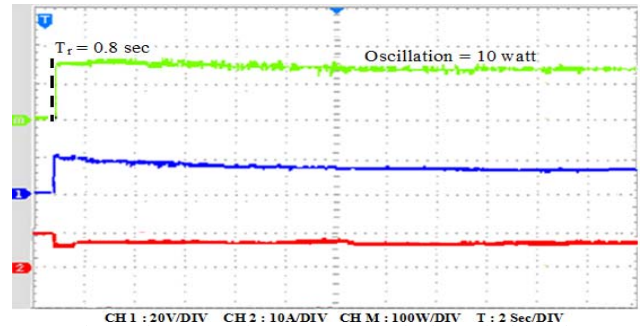

Fig 17 The Proposed Fuzzy Logic Method Practical Result

## VII. CONCLUSION

An AFLC are proposed for MPPT of PV module. The proposed AFLC is implemented and tested in comparison with other MPP techniques such as perturb and observe, Fuzzy and adaptive fuzzy . The MPPT techniques are not only designed to overcome atmospheric condition, such as temperature and insulation, but handles also effective load variations by controlling a buck-boost converter.

The simulation and the practical results illustrates that it is not recommended to apply perturb and observe and the Error methods due to their large rise time and power oscillations. It is clear that FLC is suitable for MPPT but it need to be adaptable to overcome all atmospheric condition and load variations rapidly. The proposed adaptive fuzzy (AFLC) method is the most effective and robust method to track the maximum power from the PV array. It accelerates the tracking process for the generated maximum power from the PV array.

Selecting the adaptation parameters of AFLC is carried out manually but it is necessary to study its effect and tuning in the future. In addition, applying the technique for grid connected will be addressed in the future.

## REFERENCES

- [1] F. A. O. Aashoor, F. V. P. Robinson, "A Variable Step Size Perturb and Observe Algorithm for Photovoltaic Maximum Power Point Tracking", 47th Universities Power Engineering Conference (UPEC), 2012, pp.1 -6
- [2] M. Adly, H. El-Sheni, M. Ibrahim, "Maximum Power Point Tracker for a PV Cell using a Fuzzy Agent adapted by the Fractional Open Circuit Voltage Technique", 2011 IEEE International Conference on Fuzzy Systems June 27-30, 2011, Taipei, Taiwan
- [3] M.S. Ait Cheikh\*, C. Larbes†, G.F. Tchoketch Kebir and A. Zerguerras, "Maximum power point tracking using a fuzzy logic control scheme", Revue des Energies Renouvelables Vol. 10 N°3 (2007) 387–395
- [4] Christopher A. Otieno, George N. Nyakoe, Cyrus W. Wekesa, "A Neural Fuzzy Based Maximum Power Point Tracker for a Photovoltaic System", DOI: 10.1109/AFRCON.2009.5308552, pp. 1 - 6 IEEE AFRICON, 2009
- [5] Eduardo I. Ortiz-Rivera, "Maximum Power Point Tracking using the Optimal Duty Ratio for DC-DC Converters and load Matching in photovoltaic applications", Applied Power Electronics Conference and Exposition, APEC 2008, Twenty-Third Annual IEEE, pp. 987-991
- [6] Dimosthenis Pefitis\*, Georgios Adamidis\* and Anastasios Balouktsis, "A New MPPT Method for Photovoltaic Generation Systems Based on Hill Climbing Algorithm", ICEM 2008. 18th International Conference of Electrical Machines, pp.1 - 5
- [7] Haitham Hassan, Mahmoud abuzaid, Moutaz Soliman, "Maximum Power Point Tracking for PV Systems", The 21th International Conference on Computer Theory and Applications ICCTA, IEEE 2011
- [8] Recep Cakmak, Ismail H. Altas, Adel M. Sharaf, "Modeling of FLC-Incremental Based MPPT Using DC-DC Boost Converter for Standalone PV System", Innovations in Intelligent Systems and Applications (INISTA), IEEE 2012, pp.1 -5.
- [9] Sung-Jun Kang, Jae-Sub Ko, "A Novel MPPT Control of Photovoltaic System Using FLC Algorithm", 11th International Conference on Control Automation and Systems (ICCAS), Korea, 2011 pp. 434-439.