

Sensorless detection of rotor position in switched reluctance motors

Yasser G. Dessouky

Arab Academy for Science and technology
Dept. of Electrical and Control Engineering
Miami, P.O.Box: 1029, Alexandria, Egypt

- Abstract: This paper introduces a new sensorless rotor position detection technique for switched reluctance motor drives. Two unexcited phases are probed simultaneously with fixed length current pulses from the main converter and the resultant current magnitudes are used to determine the rotor position, independent of motor parameters. The operation of the new technique is explained and the drive system is detailed. The technique is applicable to SR motors of phase number of four and greater. The sensing circuit is modelled, and theoretical and experimental results are presented.

Keywords: sensorless control, switched reluctance motors

1. Introduction

Recent interest in doubly salient switched reluctance motor (SRM) drives has involved many researches because of the drives cost advantages and ruggedness, which make it suitable for variable speed applications. The principles of operation for the drive are established (e.g. [1]-[2]). The torque developed by the motor is proportional to the rate of change of stator phase inductance which varies from a maximum, L_a , when a rotor pole is aligned with the corresponding stator pole and is a minimum, L_u , when the same poles are unaligned. For optimal torque production, the phase current is switched on at the start of the rising inductance period and is switched off before the decreasing inductance period. Such control requires accurate measurement of rotor position. The rotor position can be measured directly by using mechanical devices such as Hall sensors or opto-interrupters and a slotted disk. For better resolution, a more accurate but expensive shaft encoder can be used. However if the rotor position is measured indirectly, termed sensorless, a cheap and accurate drive can be obtained. A new method of using phase inductance in the estimation of SRM rotor position is presented and investigated in this paper. The method is based on using the

main converter to inject short, fixed-length, diagnostic current pulses simultaneously in two unexcited quadrature phases and the position is derived from the current magnitudes. An aspect of most of the previous sensorless techniques is that they required knowledge of the phase inductance values whereas this method is totally independent of motor parameters. Some of this previous sensorless SRM control work is reviewed. The principle of operation of the new method is explained and a mathematical expression of rotor position as a function of unexcited phase currents is derived. The drive system is detailed with emphasis on the electronic detection circuitry. A software model is presented to simulate the sensing circuit. Experimental and theoretical results are presented and factors affecting the performance are discussed.

2. Previous work

Earlier researches have detected the rotor position in a number of indirect ways [3]-[14]. Some methods are suitable at low speeds while others are only suitable at high speeds. Generally, the research can be classified into three groups as follows:

2.1 Unexcited phase measurement techniques

Unexcited phase measurement methods estimate the position from a non-excited phase. Difficulties are due to magnetic saturation, converter voltage ripple, magnetic coupling between on-phases producing torque and off-phases sensing the position and quantisation introduced by a digital implementation.

- (1) In [3] the peak current resulting from the application of fixed duration voltage pulses to a non-active phase is measured. A state observer is used to filter the measured position dependent data and estimate the shaft velocity.
- (2) An estimator which applies short duration pulses to two unexcited phases is explained in [4]. The current of each phase is processed individually to calculate the corresponding phase inductance. A pair of angles for one such unexcited phase inductance is shifted by a value equal to the phase displacement between the two unexcited phases and shifted angles are then compared to the angles of the second phase to determine which angles match. The matching angle is the estimated rotor position.
- (3) The phase winding in [5] is connected to an oscillator designed to measure the inductance of a non-conducting phase by using a linear frequency modulated (FM) converter whose output is decoded to get the shaft position signal. The advantage of this method is the non-sensitivity of speed upon the corresponding demodulated signal.
- (4) In [6], phase modulation (PM) and amplitude modulation (AM) techniques are used to extract the phase and amplitude variations respectively of the phase current, due to time varying inductance when a sinusoidal voltage is applied to a non-conducting coil in series with a resistor. The variations are then converted to indicate rotor position.

The main disadvantage of injecting current is the negative torque produced. However, excitation of 10% the rated current can limit the negative torque to approximately 2% of rated torque [3].

2.2 Current/Voltage sensing techniques

With electrical sensing techniques the position is estimated from the excited phase producing torque.

- (1) In [7], the modulating effect of the motional emf on the current waveform which is dependent on rotor position is observed. The low cost of this method is an advantage but it is unable to operate at low speeds where the motional emf approaches zero.
- (2) A sophisticated method based on state observers was presented in [8]. A powerful processor is needed for real time computation.
- (3) Flux estimation by means of voltage integration and inductance calculation with a simple phase model is presented in [9]. The problems are model accuracy and integration accuracy.
- (4) In [10], synchronous demodulation is used to extract the reactive component of the motor phase current at the PWM frequency. The amplitude of this component is a direct measure of the angle dependent phase inductance.
- (5) Rotor position information is achieved in [11] by differentiating the current or voltage signal of an excited phase when the rotor moves from the unaligned position into the overlap region and as a result, the current or voltage gradient will decrease significantly indicating the rotor position.

2.3 Robust control techniques

Robust control strategies do not need information about the rotor position because they assume that the motor is synchronised.

- (1) The scheme presented in [12] permits the motor to run in the steady state with a narrow conduction angle. Under transient or overload conditions, the conduction pulse is increased in response to a change in the dc link current. The method is apparently aimed to operate at fixed rather than variable speed.

3. New principle of rotor position detection

The method introduced in this paper injects from the main converter short fixed length diagnostic current pulses simultaneously in two unexcited phases. In a 4-ph SRM (8/6), if the inductance of each phase is approximated as a sinusoidal waveform, neglecting magnetic saturation and mutual inductance between phases which is practically valid for small current

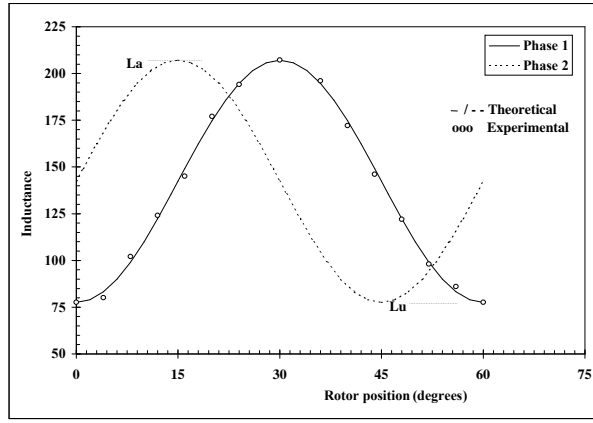

Fig.(1) The relationship between phase inductance and the rotor position

pulses, then L_1 and L_2 , the inductance of phase 1 and 2 respectively shown in figure 1, can be expressed by:

$$\begin{cases} L_1 = L_o - L_m \cos 6\theta \\ L_2 = L_o + L_m \sin 6\theta \end{cases} \quad (1)$$

where

$$L_o = \frac{L_a + L_u}{2}, \quad L_m = \frac{L_a - L_u}{2}$$

θ : rotor position with reference to the unaligned position of phase 1, and L_u, L_a : unaligned and aligned phase inductances, respectively.

Differentiating (1) w.r.t. position, θ , yields:

$$\begin{cases} \frac{dL_1}{d\theta} = 6L_m \sin 6\theta \\ \frac{dL_2}{d\theta} = 6L_m \cos 6\theta \end{cases} \quad (2)$$

Dividing the two parts of (2) gives:

$$\frac{dL_1}{d\theta} / \frac{dL_2}{d\theta} = \tan 6\theta \quad (3)$$

For a small signal model, the L.H.S of (3) can be approximated as:

$$\frac{dL_1}{d\theta} / \frac{dL_2}{d\theta} = \frac{\Delta L_1}{\Delta\theta} / \frac{\Delta L_2}{\Delta\theta} \quad (4)$$

where ΔL_1 and ΔL_2 are the inductance changes of phase 1 and phase 2 respectively and $\Delta\theta$ is the increase in rotor position in one sample step.

Therefore from (3) and (4):

$$\tan 6\theta = \frac{\Delta L_1}{\Delta L_2} \quad (5)$$

Each non positive torque producing phase is probed by high frequency current pulses with a fixed on-time t_{rise} as shown in figure 2a. Before the commencement of the next current probing pulse the phase current should reduce to zero, such that $t_{rise} + t_{fall} < \tau$. The appropriate phase voltage equation during probing is given by :

$$V = iR + L \frac{di}{dt} + i \frac{dL}{dt} \quad (6)$$

Assuming the iR component is small (since i is small as well as iR being low in SR motors), and the motional emf is unchanged within a sample period t_{rise} and between consecutive high frequency samples τ , then equation (6) becomes:

$$L = \frac{t_{rise} (V - k(\omega))}{I} \quad (7)$$

where $k(\omega)$ is the motional emf.

Therefore, the inductance change of phase 1 between two consecutive current probes is given by:

$$\begin{aligned} \Delta L_1 &= L_{1,\tau+1} - L_{1,\tau} \\ &= t_{rise} (V - k(\omega)) \left(\frac{1}{I_{1,\tau+1}} - \frac{1}{I_{1,\tau}} \right) \end{aligned} \quad (8)$$

where $I_{1,\tau+1}$ and $I_{1,\tau}$ are the peak currents at the normalised times $\tau + 1$ and τ respectively [3].

Similarly, the inductance change in phase 2 is given by:

$$\Delta L_2 = t_{rise} (V - k(\omega)) \left(\frac{1}{I_{2,\tau+1}} - \frac{1}{I_{2,\tau}} \right) \quad (9)$$

where $k(\omega)$ is the same value in equation (8) and (9), since it is the motor back emf.

Dividing (8) by (9) and equating with (5) yields:

$$\theta_{\tau+1} = \frac{1}{6} \arctan \left(\frac{\left(\frac{1}{I_{1,\tau+1}} - \frac{1}{I_{1,\tau}} \right)}{\left(\frac{1}{I_{2,\tau+1}} - \frac{1}{I_{2,\tau}} \right)} \right) \quad (10)$$

Therefore detecting the peak currents simultaneously in two unexcited phases results in absolute rotor position within any of the six possible rotor sextants. This rotor angle is independent of speed and inductance. Figure 2b depicts phase current waveforms where each phase is excited during the positive inductance rate of change to produce torque and probing diagnostic pulses are injected during the negative inductance rate of change to sense position. It is also seen that during each 15° degrees period, two phases are excited simultaneously to produce torque while the remaining two have current pulses injected for position sensing. Table 1 summarises the operation of the four phases over a 60° degrees cycle.

Angle range	0 - 15°	15° - 30°	30° - 45°	45° - 60°
Excited phases	2,1	4,1	4,3	2,3
Unexcited phases	4,3	2,3	2,1	4,1

Table 1. Operation of the four phase currents

4. Drive system

Figure 3 shows a schematic diagram for the drive system which consists of :

- (1) a 500 W, 4-ph SRM, the details for which are given in table 2,
- (2) asymmetrical half bridge converters where each phase is controlled by two MOSFET switches and two diodes as shown in figure 4,
- (3) gate drive circuits which isolate the high and low voltage sides, convert the TTL control signals into equivalent CMOS driving signals and supply the gate of the MOSFET switches with the transient current needed for switch on and off,
- (4) current transducer circuit which detects the current in each phase and produces isolated feed back current signals,
- (5) multiplexer MUX,
- (6) demultiplexer DEMUX,

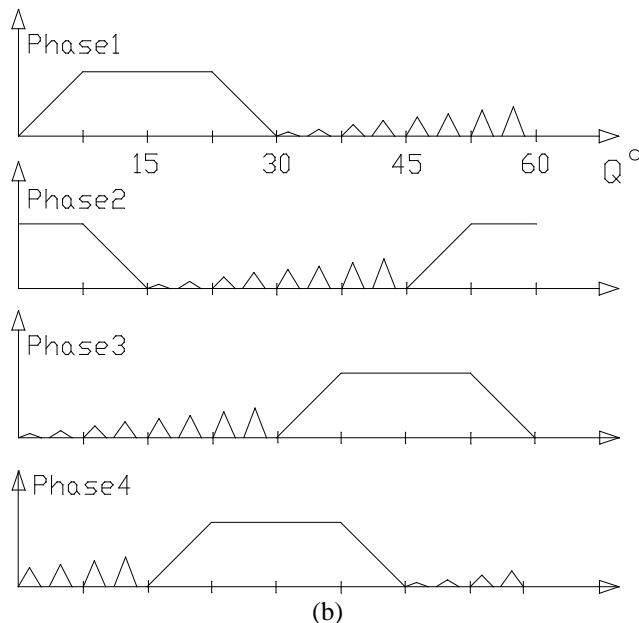
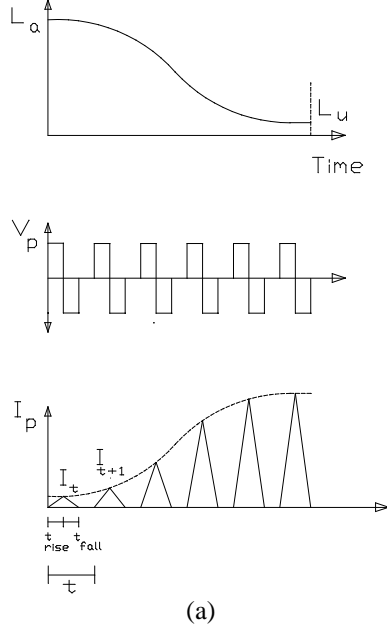
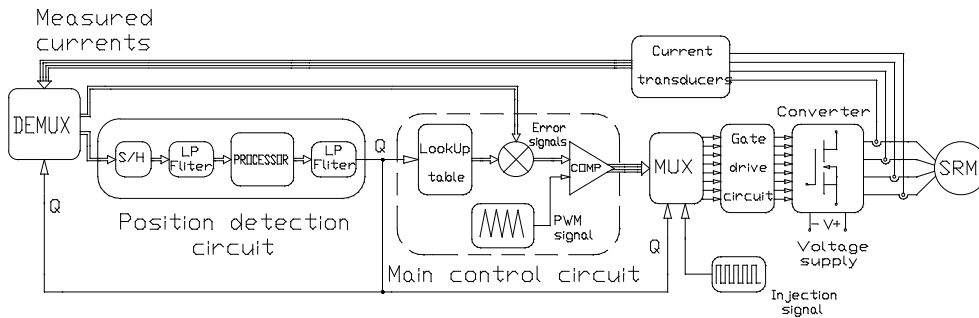

Fig. (2): (a) Inductance, voltage and current during phase injection and (b) current waveforms of the 4-ph SRM

- (7) position detection circuit and
- (8) main SR control circuit.

The demultiplexer feeds the signals from the two excited phases to the main control circuit and the signals from the two unexcited phases to the position detection circuit. In the main control circuit, the demand currents



Fig(3) Schematic diagram for the drive system

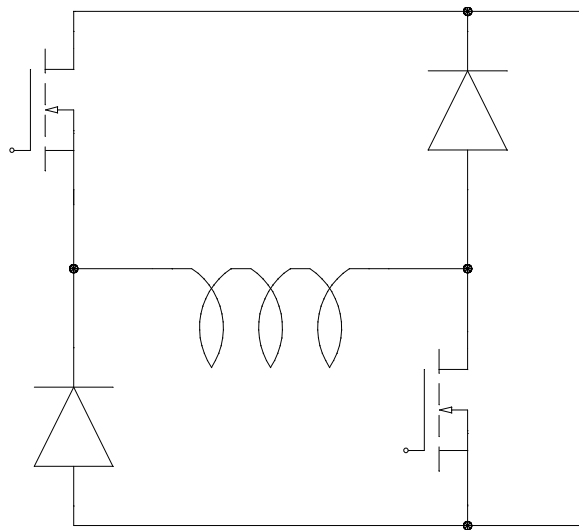

Fig. (4) Asymmetric half bridge converter per phase

8/6 stator rotor poles	Supply Voltage = 300 V
Rated current = 2.4 A	Phase resistance = 9.6 Ω
Outside frame diameter = 125 mm	Stack length = 47 mm
No. of turns per phase = 710	Bore diameter = 65 mm
Unaligned inductance = 79.6 mH	Aligned inductance = 216.2 mH

Table 2. Motor details

are produced from a look-up table according to the estimated rotor position and compared with the measured currents. The error signals are pulse width modulated to generate the torque producing signals. According to the estimate position, the multiplexer directs to the eight gate drive circuits the torque producing signals from the main control circuit and the injected pulse signal train. The two unexcited phase currents are fed to the position detection circuit and the peak values are sampled and held just before the end of each fixed length diagnostic period and then fed to low pass input filters. Sampling occurs just before the fixed pulse length ends in order to avoid switching noise problems. The two analogue signals are fed to the A/D converters of an embedded controller which evaluates the mathematical expression in equation (10) and produces the rotor position in digital form.

For observation purposes, the digital position information can be converted to analogue and passed through a low pass filter.

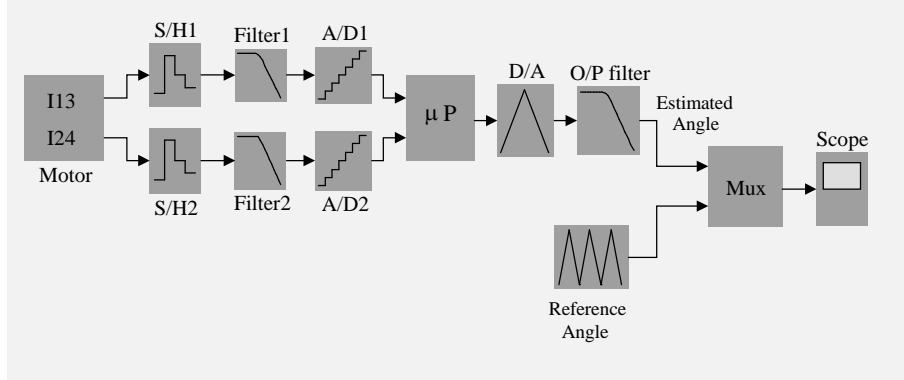

Fig. (5) Schematic diagram for the position detection circuit simulation

5. Simulation

The performance of the rotor position detection circuit is dependent on parameters such as the current injection frequency, the input and output filter characteristics and the algorithm frequency. Software simulation is used to investigate the effect of these parameters on circuit performance. The circuit is simulated using SIMULINK software as shown in figure 5 where the MOTOR block generates the current signals of the two unexcited phases. Since the currents in phase 1 and phase 3 are 180° electrically separated, they

are seen as a periodical current I_{13} . The same applies to the currents in phases 2 and 4, which are seen as I_{24} . The two signals pass through synchronised zero order sample and hold circuits to detect current values at t_{rise} , low pass input filters to remove the injection frequency component and A/D converters. The PROCESSOR block calculates rotor position according to equation (10). The digital data is processed at a sampling frequency much higher than the current injection frequency. An output low pass filter is used to remove the processing frequency component from the position signal. To compare the angle estimated by the sensing circuit with the actual angle, a reference saw tooth signal is generated from an absolute position shaft encoder.

6. Results

The negative torque developed by the sensing current pulses is inversely proportional to injection frequency. Maximum probing current, I_m , of 10% the rated current takes place at the unaligned position and limits the negative torque to approximately 2% of the rated torque [3]. With reference to equation (7), assuming $t_{rise} = t_{fall} = \tau/2$ (since only $\pm V$ loops are used), the current injection frequency, f , can be approximated by:

$$f = \frac{V}{2 I_m L_u} \quad (11)$$

For this motor, see table 2, t_{rise} is $50\mu s$ and the maximum current probing frequency is 12kHz, after which the current pulses begin to merge and become too small, hence noisy. The injection frequency is set to 10kHz. The PWM frequency for chopping the current producing torque is limited by the type of the power switch. For the BUZ384 MOSFETs, a chopping frequency of 40kHz is used. The higher the sampling frequency, the smaller

the angle change per sampling step and consequently the more accurate the angle estimation. The processing cycle frequency is set much higher than the current injection frequency and limited by the speed of the processor, A/D and D/A converters. The processing frequency is 80kHz which gives eight times over sampling. The phase delay between the actual and estimated angles due to the input and output filters is speed dependent. Figure 6 shows the relationship between the phase delay and speed for BUTTERWORTH 4th order and CHEBY-CHEV I 4th order, 0.1 dB ripple in the pass band, filters at different cut-off frequencies. It is seen that the CHEBY-CHEV I filter has less phase delay than the BUTTERWORTH filter. It is also seen that the higher the cut off frequencies, the lower the phase delay in the frequency range of interest but the higher the distortion in the estimated angle waveform. The phase delay is directly proportional to the motor speed. However setting the input and output cut-off frequencies to 2kHz

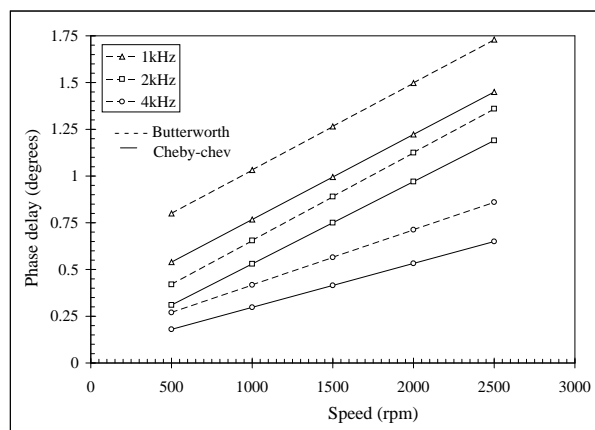

(a)

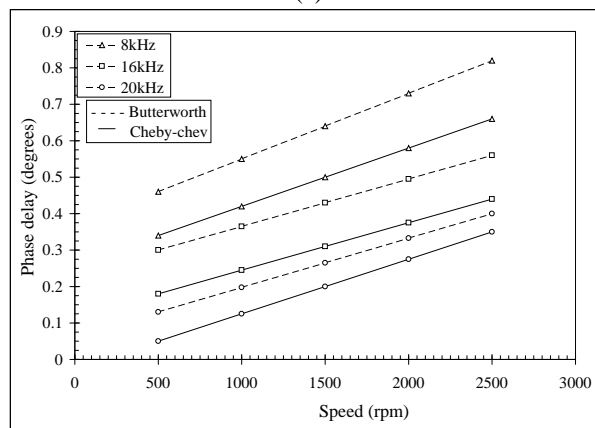

(b)

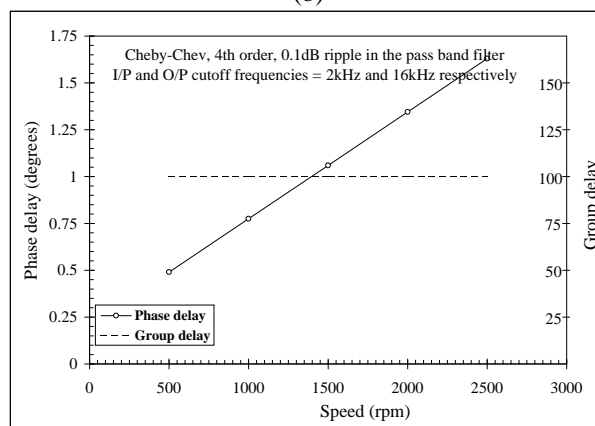

(c)

Fig. (6): The relationship between phase delay and the speed with (a) I/P, (b) O/P and (c) both filters (phase and group delay)

and 16kHz respectively results in a good estimated angle waveform with minimal phase delay (1.06 degrees = 3.5% at 1500rpm). Figure 7 shows the theoretical waveforms in the different parts of the position detection circuit and figures 8 and 9 show the experimental current waveform in two adjacent phases at 1000 rpm and the estimated angle waveform for different speeds respectively. No motor load or mutual inductance effects were observed.

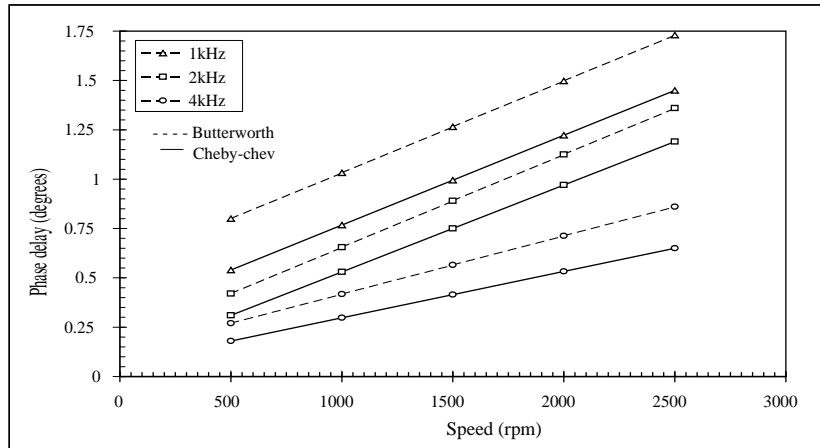

(a)

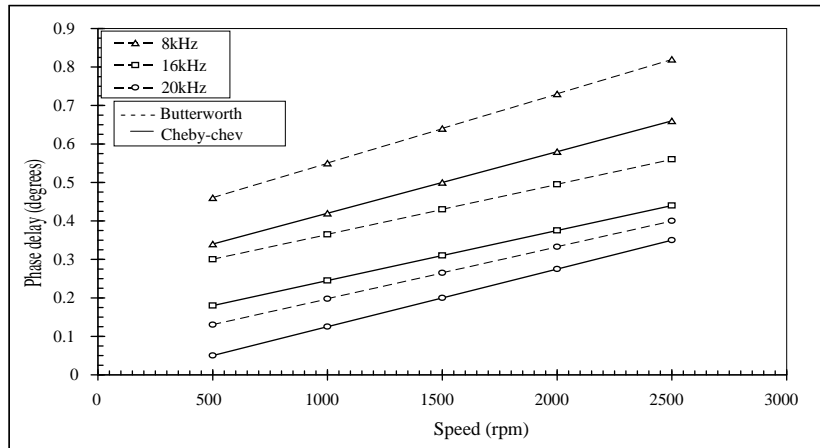

(b)

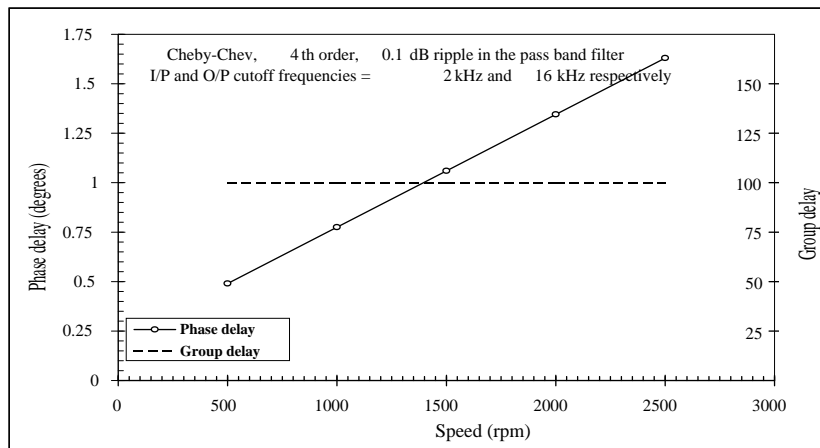

(c)

Fig. (7): Theoretical waveforms from the (a) S/H, (b) I/P filters and (c) O/P filter

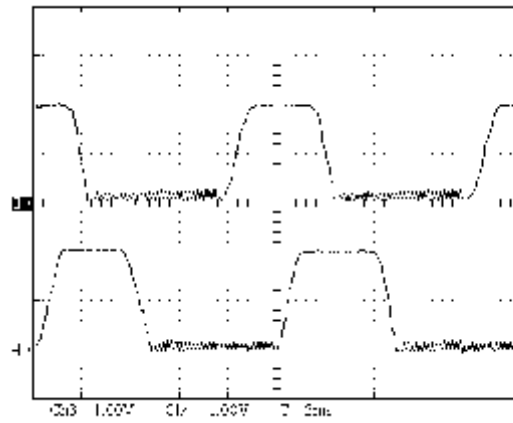
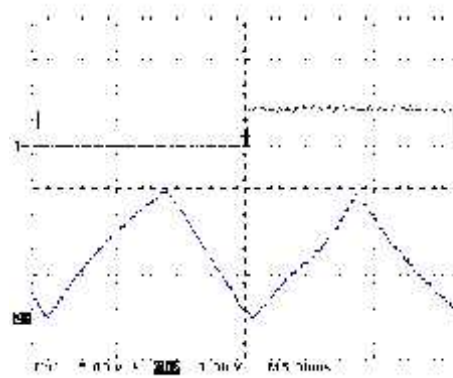
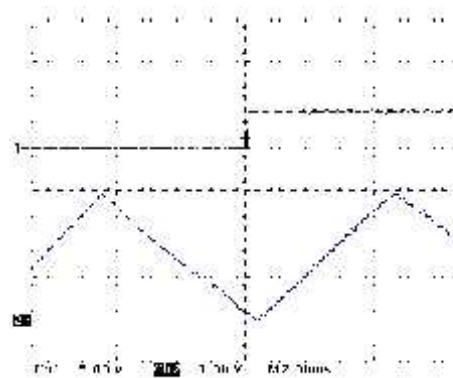

Fig. (8): Experimental current waveforms in two adjacent phases at 1000 rpm



(a)



(b)

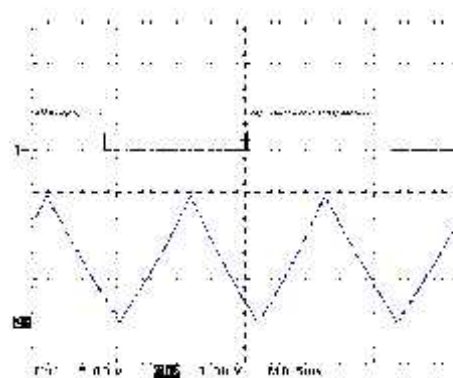

(c)

Fig. (9): Estimated position with respect to a reference waveform at (a) 200 rpm, (b) 400 rpm and (c) 3000 rpm

7. Discussion

- The 2kHz low pass input filters for the position detection circuit decrease current signal waveform distortion caused by the mutual inductance between on and off phases and voltage converter ripple. The angle estimation technique depends on the relative rather than absolute magnitude of the inductance gradient and the probing current dynamic range is fixed and only about 3:1. Therefore an eight bit A/D system can be used. The input filters cause a phase delay between the actual and estimated rotor angles.
- Ñ It is seen that performance is independent of motor parameters and insensitive to supply voltage ripple and variations.
- The new technique can be applied to SRM of phase number of four and greater where in each case the mathematical expression of the rotor angle position would be different but still independent of motor parameters. The technique can not be applied to single or two phase SRM. In the three phase motor case, if each phase current is excited for torque production for two thirds of the inductance rise period, [4], and diagnostic pulses are injected for the rest of the inductance cycle, then two unexcited phases will be available for position estimation as shown in figure 10. However rated torque is decreased.
- Ñ Motor starting can be achieved in a similar way as explained in [14] where each phase is pulsed with a short voltage pulse using existing hardware. Then the processor compares the relative current magnitudes in phases 1 and 3 and those in phases 2 and 4 at the end of the voltage pulse time. The rotor sextant (table 1) is determined as a function of the largest currents sensed. As a result the processor can then start the motor in a clockwise or counter-clockwise direction utilising a predetermined switching sequence.
- Ñ In a digital control system, the output analogue filter can be replaced by a software digital filter, if such a filter is required.
- Position information is sampled at a fixed 10kHz, hence at higher speeds position resolution decreases. Accuracy is not affected, only the number of samples per revolution decreases. At 3000 rpm each rotor sextant has 33 samples. For higher position resolution, the current injection period (and hence current magnitude) must be reduced thereby increasing any noise problems. The input filter cut-off frequency can be increased.
 - A commercial TMS320C31 DSP card with filters and A/D-D/A converters was used for convenience. Because only 8 bit A/Ds are needed, a 16 bit embedded controller is suitable for this application.
 - It is assumed that the motor operates only in a 2-phase on mode. That is, all main torque producing currents are reduced to zero before the negative torque region of each phase.
 - Figure 6c can be used to estimate error dependence with speed. Essentially the estimate at all speeds is delayed by 100 μ s from the real waveform, up to 1 kHz (or half the input filter cut-off frequency). About 10 % of this delay is due to the 16kHz output filter, which may not be necessary for a digital controller. Low speed accuracy is

determined by A/D accuracy and no valid position information results at standstill. Figure 9 shows good results for a 15:1 speed range. With the system 8-bit

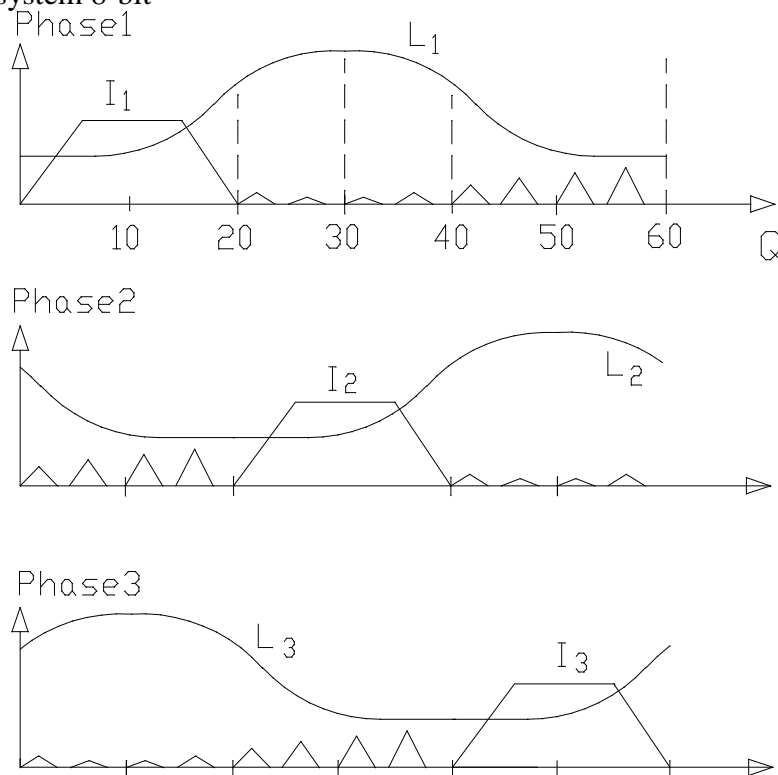

Fig. (10): Current waveforms of the 3-ph SRM

A/D's a usable 50:1 speed range is possible, while 10-bit A/D's extend the range to over 100:1. The linearity of the estimator deteriorates at low speeds but linearity can be improved by decreasing the sampling frequency and increasing the length of the probing pulse. The input filter cut-off frequency should be correspondingly decreased.

8. Conclusion

A new sensorless SRM rotor position detection technique has been introduced based on probing two unexcited phases simultaneously with short fixed length voltage pulses from the main converter and evaluating the resulting currents to determine rotor position. The technique requires no knowledge of motor parameters, is not sensitive to supply voltage variations and can be applied to SRM of phase number of four or greater. Using the proposed method on a three phase motor decreases rated torque. The drive system has been detailed and a software model for the sensing circuit was presented. Experimental and theoretical results have been presented with a study of the effects of input and output filters cut-off frequency on performance. A motor starting method was discussed.

References

1. Lawrenson P J: 'Switched reluctance drives: A perspective,' ICEM'92, Manchester, UK, 1992, pp. 12-21
2. Pollock C and Williams B W: 'Power converter circuits for switched reluctance motors with the minimum number of switches,' IEE Proc., Vol. 137, Pt. B, No. 6, Nov. 1990, pp. 373-384

3. Harris W D and Lang, J H: 'A simple motion estimator for variable-reluctance motors,' IEEE Trans. on IA, Vol. 26, No. 2, March/April 1990, pp. 237-243
4. MacMinn S R and Roemer P B: 'Rotor position estimation for switched reluctance motor,' US patent, no. 4,772,839, Sept. 20, 1988
5. Ehsani M, Husain I and Kulkarni A B: 'Elimination of discrete position sensor and current sensor in switched reluctance motor drives,' IEEE Trans. on IA, Vol. 28, No. 1, Jan/Feb 1992, pp. 128-135
6. Ehsani M, Mahajan S, Ramani K R and Husain I: 'New modulation encoding techniques for indirect rotor position sensing in switched reluctance motors,' IEEE-IAS Conf. Proc., Oct. 1992, pp. 430-438
7. Kuo B C and Cassat A: 'On current detection in variable-reluctance step motors,' Proc. 6th incremental motion control systems and devices Symp., Urbana, IL, May 1977, pp. 205-220
8. Lumsdaine A and Lang J H: 'State observer for variable-reluctance motors,' IEEE Trans. on IE, Vol. 37, No. 2, April 1990, pp. 133-142
9. Lyons J P, MacMinn S R and Preston M A: 'Flux/Current methods for SRM rotor position estimation,' IEEE-IAS Conf. Proc., Dearborn, MI, Sept. 1991, pp. 482-487
10. Egan M G, Harrington M B and Murphy J M D: 'PWM-based position sensorless control of variable reluctance motor drives,' EPE'91, Vol. 4, Firenze, Italy, Sept. 1991, pp. 24-29
11. Kjaer P C, Blaabjerg F, Pedersen J K, Nielsen P and Andersen L: 'A new indirect rotor position detection method for switched reluctance drives,' ICEM'94 Proc., Vol. 2, Paris, Sept. 1994, pp. 555-560
12. Miller T J E, Bass J T and Ehsani M: 'Stabilisation of variable-reluctance motor drives operation without shaft position feedback,' Incremental motion control systems and devices Symp., Urbana, Illinois, 1985, pp. 361-368
13. Ray W F and Al-Bahadly I H: 'Sensorless methods for determining the rotor position of switched reluctance motors,' EPE'93 Proc., Vol. 6, Brighton, UK, Sept. 1993, pp. 7-13
14. Belanger D J: 'Simple starting sequence for variable reluctance motors with rotor position sensor,' US patent, no. 5,051,680, Sept. 24, 1991

قياس موقع العضو الدائر لمحرك الممانعة المغناطيسية بالاستشعار

د. ياسر جابر عبد الرازق

الأكاديمية العربية للعلوم و التكنولوجيا و النقل البحري
قسم الهندسة الكهربية و التحكم أبقير - الاسكندرية

ملخص

هذه الورقة البحثية تبحث في طريقة لقياس موقع العضو الدائر لمحرك الممانعة المغناطيسية بالاستشعار وذلك عن طريق إمداد الملفين الغير مشارين بجهد نبضي له طول موجي ثابت من نفس المغذى الرئيسي ثم يستخدم التيار الناتج لتحديد موضع العضو الدائر و ذلك بغض النظر عن قيمة ثوابت المحرك القياسية. الطريقة المقترحة يمكن استخدامها لمحرك رباعي الأوجه أو أكثر. تم محاكاة دائرة الاستشعار و كذلك اختبار الدائرة نظريا و عمليا.